

Sigma 2008B SERIAL DIGITAL CONDUCTIVITY METER

OPERATING INSTRUCTIONS



Xiamen Tianyan Instrument Co., Ltd.

CONTENTS

一、	APPLICABILITY AND FEATURES	1
二、	TYPICAL APPLICATIONS	1
三、	MEASURING SYSTEM INSTRUCTIONS	3
四、	HARDWARE COMPONENTS OF PRODUCT	4
五、	OPERATING INSTRUCTIONS	5
5.1	Keyboard instructions	5
5.2	Display icon definition	6
5.3	Operating concepts	6
5.3.1	Turn of/ turn off	6
5.3.2	Measurement	7
5.3.2.1	Examples and conditions	7
5.3.2.2	Measuring probe selection	8
5.3.2.3	Measurement interface introduction.....	8
5.3.2.4	Measurement unit	9
5.3.2.5	Methods of compensation temperature	9
5.3.2.6	Methods of temperature coefficient.....	10
5.3.2.7	Methods of curvature compensation coefficient.....	10
5.3.3	Calibration.....	11
5.3.3.1	Calibration period.....	11
5.3.3.2	Quantity of Calibration Block	11
5.3.3.3	Calibration mode introduction.....	11
5.3.3.4	Items before calibration.....	12
5.3.3.5	High value block calibration	12
5.3.3.6	Low value standard calibration blocks	13
5.3.4	Setting	13
5.3.4.1	Setting menu.....	15
5.3.4.2	Measurement Interface	15
5.3.4.3	Temperature compensation mode.....	16
5.3.4.4	Temperature coefficient setting	17
5.3.4.5	Calibration block	18
5.3.4.6	Selection frequency and probe	19
5.3.4.7	Unit selection	20
5.3.4.8	Back-light selection.....	20
5.3.4.9	Data query	21

5.3.4.10 Data uploading	21
5.3.4.11 Data storage mode	23
5.3.4.12 Time setting	24
5.3.4.13 Language selection	24
六、 INFLUENCING FACTORS OF MEASUREMENT	25
6.1 Temperature influence	25
6.2 Lift-off influence	27
6.3 Material thickness influence	27
6.4 Camber influence.....	28
6.5 Edge Effect	29
七、 POINTS FOR ATTENTION AND MAINTENANCE	29
八、 USERS NOTES.....	30
APPEDIX1: TABLE OF CONDUCTIVITY VALUE FOR COMMON MATERIAL AND TEMPERATURE COEFFICIENT	31
APPEDIX2: CONTACTS	31

Thank you very much for selecting the portable style eddy conductivity meter of serial Sigma 2008B, This serial is the upgrading product of Sigma 2008A, Which have the leading technology performance, can totally instead of the similar products overseas. Sigma 2008B adding a new Frequency testing of 500KHz, This can accurate measure the thinner test pieces. The Application range is more extensive after adding continuity measurement and camber measurement mode. In the meanwhile adding lots of temperature compensation mode can make sure measuring the temperature accurately under difference temperature conditions.

一、 **APPLICABILITY AND FEATURES**

Sigma 2008B is the product of digital conductivity meter designed with eddy phase. These products commonly used in industries of metallurgy, machinery, electric power, aviation and aerospace, nuke, military, etc.

Characteristics:

- Beautiful appearance, easy to carry about and grasp, simple and convenient to use.
- Big screen, big character; displaying measured result, working frequency, temperature, temperature coefficient etc. simultaneously.
- Two kinds of switchable frequencies for Sigma 2008B, 60KHz for aviation industry standard, 500KHz for detecting sheet metal.
- Special temperature coefficient setting and auto calibrating mode, convenient and reliable for user to operate.
- Up to 500 μ m lift-off compensation design, for maintaining the measuring accuracy when painted, coated or dusty on surface.
- The variety of temperature compensation mode design, combined with temperature coefficient, instruments can ensure the measurement accuracy under different testing temperature.
- With interchangeable probes, the user is able to change probes provided by our company without matching.
- Built-in date memory, can record 16000 sets of test date and important test parameters, you can connect the computer to generate a complete report.
- Two units (MS/m or %IACS) convenient choice, but also can directly switch resistivity in the measurement of interface.
- Three kinds of language selection: Simplified Chinese, Japanese and English.

二、 **TYPICAL APPLICATIONS**

- Conductivity and resistivity measurement of
- non-ferromagnetic material
- Determining extent of thermal treatment
- Checking thermal damage, material fatigue and crack
- Determining metal purity
- Monitoring of metal homogeneity

- Metal classification
- Monitoring of strength and hardness
- Detecting the density of powder metallurgy parts

三、 MEAURING SYSTEM INSTRUCTIONS

Model Items	Sigma 2008 B	Sigma 2008 B1
Working Freq.	60KHz and 500KHz, sine wave	60KHz sine wave
Measurement range for conductivity	0.51 %IACS to 112 %IACS, or 0.3 MS/m to 65 MS/m or resistivity 0.01538 $\Omega \cdot \text{mm}^2/\text{m}$ 到 3.33333 $\Omega \cdot \text{mm}^2/\text{m}$	
Resolution	0.1 % ~ 0.001 %IACS	
Measuring precision	$\pm 1\%$ (Temp. 0 $^{\circ}\text{C}$ ~ 50 $^{\circ}\text{C}$), $\pm 0.5\%$ (Temp. 20 $^{\circ}\text{C}$)	
Lift-off compensation	0.5mm of $\phi 14$ probe; 0.2mm of $\phi 8$ probe;	
Temp. Measuring range	0 $^{\circ}\text{C}$ ~ +80 $^{\circ}\text{C}$ (Temp. resolution 0.1 $^{\circ}\text{C}$, Temp. Measuring precision 0.5 $^{\circ}\text{C}$)	
Auto. Compensation	Testing result of conductivity adjusted to the value at temp. 20 $^{\circ}\text{C}$ automatically	
Working environment	Temp. 0 $^{\circ}\text{C}$ ~ +50 $^{\circ}\text{C}$, Related humidity 0 ~ 85% (Non-condensing)	
Display	Large screen LCD, with back-light designed, can display multiple items of important parameter simultaneously	
Power supply	Provided lithium ion battery of 3.7V、2200mA/h, continuous working about 12hours	
Probes	B type machine with diameter 14 mm working frequency of 60 KHz and diameter 8mm working frequency of 500 KHz of a probe; B1 type machine with a diameter of 14 mm working frequency of 60 KHz of a probe. Probe can be Self replacement.	
Temp. Probe	Hand-hold surface temperature sensor	
Reading memory	Save 16000 sets of measuring date	
PC Communication	RS 232 interface, Baud rate: 2400bps; Date rate:8	
Host weight	0.5KG (Including battery)	
Host size	220 mm \times 95 mm \times 55 mm	
Shell	Plastic shell	
Package and protection	High impact-resistance, portable box made of aluminum alloy, and instrument, probe, communication cable, operation manual, conductivity block, charger, instrument bracket, U-disk (or optical disk).	
Accessories	3 pieces of standard conductivity blocks, can provide more blocks for customer choose.	

四、 HAREWARE COMPONENTS OF PRODUCT



1. Host machine of conductivity meter



2. Detecting probes (φ 14mm、60KHz)



3. Special detection probe
(φ 8mm、500KHz)



4. External temperature sensor



5. Curved surface test suite



6. Leather case for main engine protection

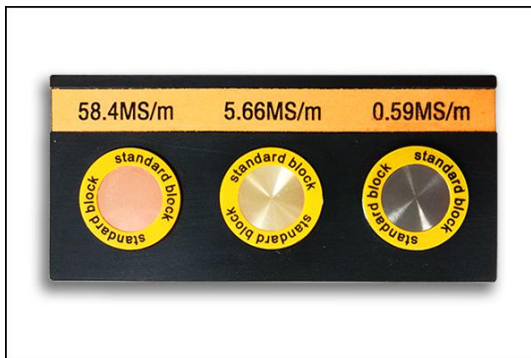

7. Conductivity standard blocks



8. Host machine stand



9. U- disk



10. Batteries recharger



11. RS 232 communication cable

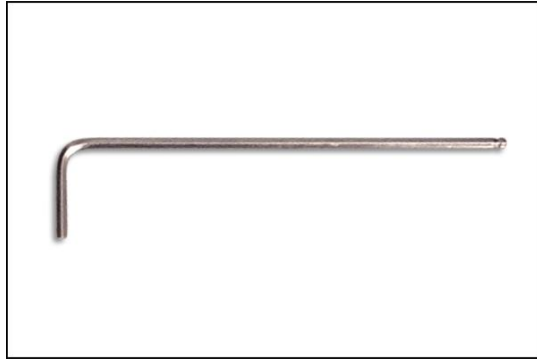

12. Hexagon wrench

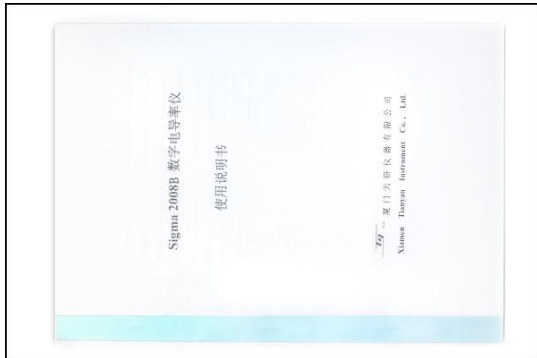

13. Operation manual



14. Portable protective box

五、 OPERATING INSTRUCTIONS

5.1 Keyboard instructions

- 5.1.1 “MEAS”: Measuring shortcut key
- 5.1.2 “STORE”: Storing date(effective on manual storing)
- 5.1.3 “CAL”: Calibration shortcut
- 5.1.4 “SET”: Functions setting
- 5.1.5 “OK”: Confirmation
- 5.1.6 “ $\frac{DEL}{UNIT}$ ”: Measuring unit conversion key (effective for measurement mode)/deleting key(effective for query mode)
- 5.1.7 “a₀”: Temperature coefficient selection

5.1.8 “ $\frac{T_A}{\eta(\varphi)}$ ”: Current temperature value input (effective measurement interface)/ Curvature diameter correction coefficient modification (effective opening the camber compensation)

5.1.9 “ $\frac{ON}{OFF}$ ”: Turn on/off

5.1.10 “ \uparrow ”: Increasing progressively or moving upwards

5.1.11 “ \downarrow ”: Decreasing progressively or moving downwards

5.2 Display icon definition

5.2.1 “” indicate the current power margin. When the power margin is less than 1/3, instrument will issue two consecutive tones every 30 seconds, then continue using a period of time, the instrument will automatically shutdown for protection, and remind should to charge now.

5.2.2 “ $TA=???$ ” indicate temperature sensor is not connected, when “temperature compensation mode” select the “temperature sensor” of “Automatic temperature compensation”, the “normal measurement mode” and the “calibration measuring mode” will appear the icon neither connected with the temperature sensor nor sensor broken nor detecting temperature is less than or equal to zero.

5.2.3 “” indicating that the buzzer alarm is turned on, when “measurement mode” select “continuity measurement” and buzzer “Beep” selected ON also, the icon of “continuity measurement mode” will display this icon.

5.3 Operating concepts

5.3.1 Turn of/ turn off

5.3.1.1 In the turning off state, press key “ $\frac{ON}{OFF}$ ” for 2 seconds, the screen appears welcome interface, and reminds to insert the probe, showing as below.

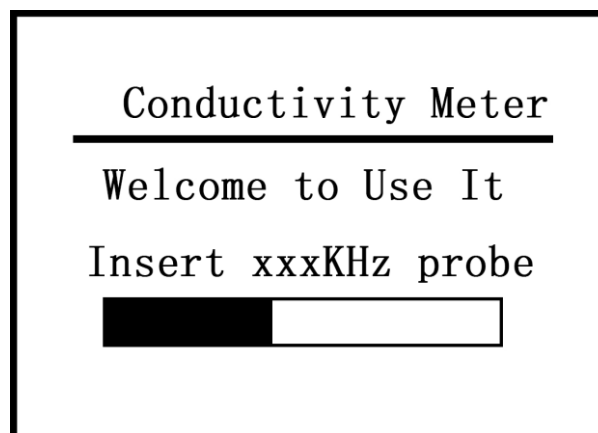



5.3.1.2 Press the measurement key “MEAS”、 setting key “SET” or calibration key ”CAL” to go into the corresponding interface directly.Or wait the welcome interface timing finished to go into the measurement interface automatically.

5.3.1.3 In the turning on state, press key“ $\frac{ON}{OFF}$ ”for about 2 seconds, this instrument is turned off and saved current setting information.

5.3.2 Measurement

5.3.2.1 Examples and conditions



There are two ways of measurements, normal measurement (flat surface  or camber ) and continuity measurement, users can select it on the measurement mode, the selection ways and conditions are as follows:

Example1: normal measurement 1”shortcut operation mode” (Factory setting mode)

This is a pseudo temperature compensation mode, it doesn't need to consider the temperature value and coefficient, as long as the following two conditions are met.

- ① Temperature of the material to be measured is almost the same as the standard temperature block, use the value of the standard block at 20°C to calibrate, then measure the conductivity for the testing material..
- ② The material temperature coefficient of the material to be measure is the same as the temperature of the standard block. If users want to measure the conductivity of the unknown material of copper and aluminium sheet, it is right to calibrate as the same temperature coefficient in the standard block (temperature coefficient of copper and aluminium is -0.004).

2.Operation methods

- ① When the material to be measured is of flat surface material, refer to “measurement mode” of the menu 5.3.4.2 to select “close camber compensation”, and set “temperature compensation mode” of the menu 5.3.4.3 into pseudo temperature compensation. Now both the temperature value T_A of measurement interface and standard interface and temperature coefficient value a_0 are display invalid “None”, that is to say it doesn't have to consider the current temperature value and select the temperature coefficient when measuring and calibrating. As long as calibrate the higher/lower value before the measurement. Then return to measurement interface to measure the conductivity of the material. (refer to 5.3.3.4~5.3.3.6 and 5.3.2.8)
- ② When testing pieces is of “convex” or “concave” material. Go to the “measurement interface” of menu 5.3.4.2 select “opening curvature compensation”. For “convex” camber, first change the hand grip $\phi 14\text{mm}$ probe into “” style, then calibrate higher and lower value on the calibration interface, return to the measurement interface, select the value $\eta(\varphi)$ of curvature compensation coefficient (refer to 5.3.2.6), adjust “” grip to the suitable position (refer to 5.3.2.2-b), then measure conductivity of the camber material.
- ③ When measuring the thin plates or small pieces (area between $\phi 8\text{mm} \sim \phi 14\text{mm}$), should change to $\phi 8\text{mm}$ (500KHz) style probe, select $\phi 8\text{mm}$ -500KHz probe in the “frequency and probe” of menu 5.3.4.6, the measuring method is the same as ①.

Example2: normal measurement 2 “Different temperature operating mode”





This mode is used that calibrations and measurements can't be operated under the same temperature circumstance (or calibration temperature isn't the same as that of testing material), such as tracking the conductivity change of the material under different temperatures, and fasting measure the conductivity under non-normal temperature conditions. This operation mode is relatively cumbersome, but it is suitable for any occasion, the accuracy is much higher. (refer to 6.1.2.2 “automatic

temperature compensation-temperature sensor” mode and 6.1.2.3 “automatic compensation-manual entering temperature” mode).

Examples 3: continuity measurement operation mode

This mode is only worked under “pseudo temperature compensation” mode, used to select the conductivity faster, and have alarm function of over upper and lower limitation. Calibrate the high value and the lower value before measurement (refer to 5.3.3.4~5.3.3.6), setting the upper and lower limitation of alarm value on measurement interface mode, back to the measurement interface can measure and select the material.

5.3.2.2 Measuring probe selection



- a. Diameter of material area is larger than 14mm for a planar working piece or concave surface, select 14m diameter (60KHZ) probe. Use the “” shape hand grip to fix the inner of the probe.
- b. Measuring the convex surface of the work pieces, select diameter of 14mm (60KHZ) probe, with “” type hand grip, adjust the vertical degree of probe plane and convex surface of work pieces, then tighten the hand grip. Remark: Should calibrate the instrument before adjusting the hand grip.
- c. Diameter of material is greater than 8mm, select diameter of 8mm (500KHZ) probe, hand with “” shape grip to push to fasten on the probe of the inner core.
- d. Select diameter of 8mm (500KHZ) probe when measure sheet materials (refer to 6.3 material thickness influence), lay down “” shape grip and fasten the probe surface on the same plane, increase the stability of the measurement.
- e. It takes 2~5 minutes to warm up after changing the new probe every time. For 500Hz probe, we suggest to warm up 5 minutes.

5.3.2.3 Measurement interface introduction

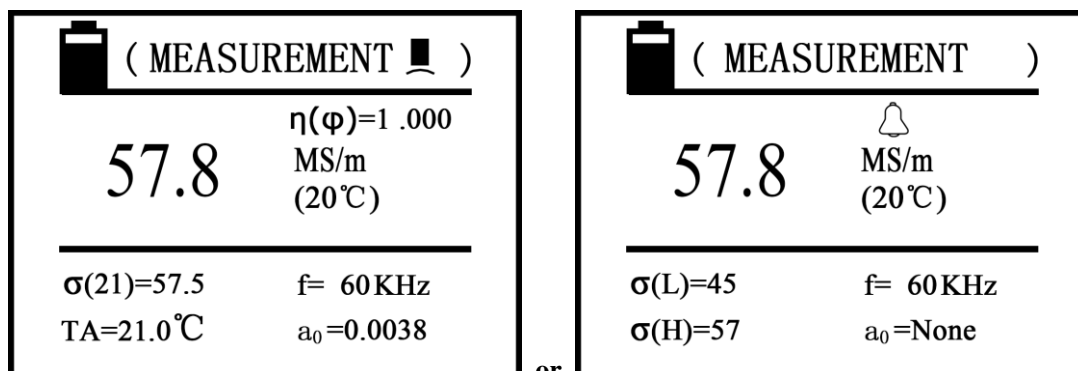
After welcome time or in the welcome, calibration and setting interface to press key "MEAS" directly, the screen appears as one of the following measurement interfaces (select see 5.3.4.2 measurement interface mode).



Explanation:

- a. The text indicates the function of the interface at the top of the screen, For example, measuring the conductivity value of the plane specimen is <measurement  >, Measure camber specimens <measurement  >.

- b. The large numbers in the middle of the screen show conductivity value tested under the temperature of +20°C or true conductivity values of camber specimen by corrected coefficient $\eta(\varphi)$ compensated.
- c. $\eta(\varphi)=\square\square\square\square$ is the curvature corrected coefficient of the camber, it is only effective after the camber compensation opened.
- d. MS/m or %IACS is unit for conductivity value, or $\Omega\cdot\text{mm}^2/\text{m}$ is the unit for the resistivity (units setting refer to 5.3.2.4).
- e. $\sigma(T_c)=\square\square\square\square$ of the bottom screen said conductivity values which measured under temperature in bracket . $\sigma(T_c)$ shows temperature value in brackets is compensation temperature value, its equal to the TA temperature value get after four homes into the rounding.
- f. $T_A=\square\square\square^\circ\text{C}$ indicates the current temperature of testing pieces measured by a temperature sensor or manual input, or display TA =None under pseudo temperature compensation mode (setting method see 5.3.4.3 temperature compensation mode).
- g. $f=\square\square\square\text{KHz}$ indicates the working frequency (setting method see 5.3.4.6 frequency and probe selection)
- h. $a_0=\square\square\square\square$ indicate the temperature coefficient of testing pieces (a =None is invalid under pseudo temperature compensation mode or continuity measurement interface)
- i. <Continuity measurement >interface, the icons  on the screen said alarm beeps open, no icon is closed. $\sigma_H=\square\square\square$, $\sigma_L=\square\square\square$ said conductivity high values and low values of separation point (seeing 5.3.4.2 measurement interface mode).

5.3.2.4 Measurement unit

Measuring interface has two units of selecting methods, one is default instrument unit "MS/m and % IACS" (see 5.3.4.7 unit selection), which used in data storage, calibration, measurement mode. Another is quick convert method, in the measurement of interface, press " $\frac{\text{DEL}}{\text{UNIT}}$ " key, press key once will converse the unit once, such as "MS/m、 %IACS、 $\Omega\cdot\text{mm}^2/\text{m}$ ", shut down and then open or from other interface returns to measurement interface, measurement unit recovery to the original default units.

5.3.2.5 Methods of compensation temperature

- a. When the specimen current temperature $T_A=\square\square\square^\circ\text{C}$ sets as reading temperature of temperature sensor (automatic temperature compensation for temperature sensor, see 5.3.4.3) , the temperature sensing end is close to the surface of the specimen until temperature stable, press " $\frac{T_A}{\eta(\varphi)}$ " button to select TA value(TA display block cursor), press the "OK" button, $\sigma(T_c)$ values in brackets immediately modified into TA temperature value and stored until the next change. Conductivity value (at 20°C) displayed in the middle screen will update according to the temperature. Remark: When $T_A=???$, compensation temperature value T_C can't be modified.

- b. When the current temperature $T_A = \square\square\square^\circ\text{C}$ sets as manual input temperature (automatic temperature compensation set as manual input temperature, see 5.3.4.3), T_A value is obtained from the following operations: press " $\frac{T_A}{\eta(\varphi)}$ " button, select T_A , press "OK" key enter the digital part, then press the " \uparrow " or " \downarrow " button to modify the numerical, press the "OK" button again, $\sigma(T_c)$ values in brackets is modified to current T_A value and saved until next modification. This method is used for no temperature sensor or automatic temperature compensation mode when tested temperature has been known already. Remark: When $T_A \leq 0.4^\circ\text{C}$ or $T_A = ???$, compensation temperature value T_c will be modified into zero which is the default value.
- c. When temperature compensation mode select pseudo temperature compensation (see 5.3.4.3), if $T_A = \text{None}$, $\sigma(TC)$ compensated temperature values in brackets is always 20°C , $\sigma(TC)$ conductivity value is the same as conductivity of middle row, press " $\frac{T_A}{\eta(\varphi)}$ " key can't select T_A Value.

5.3.2.6 Methods of temperature coefficient

- a. When temperature compensation mode select automatic temperature compensation (a_0 value meaningless in pseudo temperature compensated mode or continuity measurements interface), should be selected a_0 value based on test piece temperature coefficient. If unknown test temperature coefficient, can refer to Appendix 1: "common materials temperature coefficient" or refer to standard data which the relevant authority provided.
- b. In measuring interface, according to the temperature coefficient press key " a_0 " to select a_0 value (appear the circle around a_0), press the "OK" button, the cursor moves into digital line, press the superscript key " \uparrow " or subscript keys " \downarrow " to select temperature numerical stored in the instrument (a_1 to a_{12}), selected a needed value then press the "OK" button to confirm, the instrument default the a_0 value until the next election. If you do not press the "OK" button to confirm, 5 seconds after, the instrument automatically restore the original a_0 value.
- c. This instrument has storage space full of 12 groups (a_1 to a_{12}) temperature coefficient for the user to save the a_0 value (see the 5.3.4.4 temperature coefficient setting) for measurement call.

5.3.2.7 Methods of curvature compensation coefficient

If open camber compensation function (see 5.3.4.2 measurement interface mode), if appear $\eta(\varphi) = \square\square\square\square$ curvature correction coefficient, press the " $\frac{T_A}{\eta(\varphi)}$ " key select $\eta(\varphi)$ value (appear the circle around $\eta(\varphi)$), press "OK" key into the digital part line, according to " \uparrow " or " \downarrow " button to modify the numerical (curvature coefficient selected refer to 6.4 curve surface effects), press the "OK" key confirmation again, the instrument default the $\eta(\varphi)$ value until the next election.

This instrument's input values of curvature diameter correction coefficients are from 0.700 to 1.100.

5.3.2.7.1 In the normal measurement interface, hand-hold eddy probe from the air (distance from the specimen of > 5cm) vertically placed on the surface of the tested, when measuring stable (about 2 seconds), heard "Di" tone, instrument finish the conductivity measurement and latch measurements value automatically until the next update.

5.3.2.7.2 In continuity measurement interface, when the eddy probe near the specimen, instrument began to continues measuring, and display according to a certain time interval (about 1s) until the probe left specimens, measurement finished and recover showing the value of zero. No lock date function and save data function.

5.3.3 Calibration

5.3.3.1 Calibration period

- a. Replace the probe, shutdown the instrument after a period of time then open again, the instrument temperature compensation mode will change (such as automatic compensation into pseudo temperature compensation), the instrument should be re-calibration.
- b. When the instrument finish the preheating, for a half hour time before the operation, suggest calibrate once a time every 15 minutes.
- c. Working under the "pseudo temperature compensation mode" , compare to the recent calibration, if the calibration testing block temperature changes more than $\pm 2^{\circ}\text{C}$, proposed to re-calibrate.

5.3.3.2 Quantity of Calibration Block

- a. Using two standard test blocks (high conductivity value σ_H and low conductivity values σ_L) as the calibration for measuring the curve. Each standard block is accompanied with conductivity value and temperature coefficient numerical. Products manufacturers have provided and set two original standard test blocks, the users can set up and use standard test block by your own also (how to set go to see 5.3.4.5 calibration bock setting)
- b. High value σ_H 、 low value σ_L block selection, suggest conductivity values is falls within the range of calibration block value as possible, or closed to that of high, low value standard block.

5.3.3.3 Calibration mode introduction

In the measurement or setting the main interface press the calibration key "CAL" directly, the screen appears calibrate main interface, shown as below.

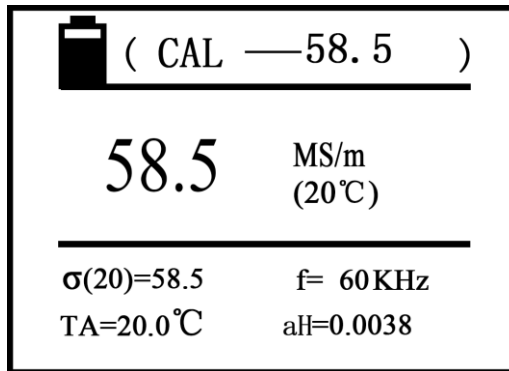

Description:

- a. "Calibration" indicates the interface function shows on the top of the screen, number next to the standard is the conductivity value which is calibrated of the standard block at 20°C conditions (the values setting method see 5.3.4.5 calibration block setting).
- b. Numerical in the middle line of the screen represented the conductivity value of the testing block after calibration at 20°C (unit of measurement instrument for the default unit)
- c. $a_H = \square\square\square\square$ (low value $a_L = \square\square\square\square$) of the screen bottom is temperature coefficient for the high value calibration block, the remaining meaning and setting of symbol $\sigma(T_c)$ 、 T_A 、 f is the same as measurement interface .(see 5.3.2.3, 5.3.2.5)

5.3.3.4 Items before calibration

Before calibration, make sure temperature of the probe, testing block and external environment is stable, then select the temperature compensation value TC of calibration block according to different temperature compensation modes (methods is the same as the measuring interface, see

5.3.3.5 High value block calibration

Enter the calibration interface, the instrument performance high value blocks calibration first (digital display next to the "calibration" at the top of the screen is setting value $\sigma_H(20)$, shown below is the standard temperature coefficient value a_H), probe vertical flat on surface of the high value block which has the same setting value of sigma $\sigma_H(20)$ 、 a_H , measuring the conductivity value.

- a. When the measured value is equal to the setting value $\sigma_H(20)$, does not need to calibrate high value, probe is placed back into the air, press the "OK" key, the instrument into the low value of the standard calibration block.
- b. When the measured value is not equal to the setting value, keeping the probe touch with the standard block, the instrument enters the automatic calibration when press the "OK" key, and issue a tone after completion.
- c. Back to calibration block again, if the error is more than 0.3%, re-calibration according to step b, until meet the requirements, then put the probe back into air, press

the "OK" key to enter the calibration block calibration.

5.3.3.6 Low value standard calibration blocks

(at the top of the screen the digital display next to the "calibration" is setting value $\sigma_L(20)$, shown below is the temperature coefficient value a_L)

- a. Probe contacts with the low value standard block which has the same setting value of $\sigma_L(20)$ and a_L , and press the "OK" button, the instrument get into automatic calibration, and issue a tone after completion.

- b. Back to measuring standard block again, if the error is more than 0.3%, Re-calibration according to step a until meet the requirements, then put the probe into the air, press the "OK" key, exit the calibration interface.

The process of all calibration is not completed, if press the measurement key "MEAS" or setting key "SET" the instrument will exist the calibration, and the calibration data is invalid this time, then return to the corresponding interface



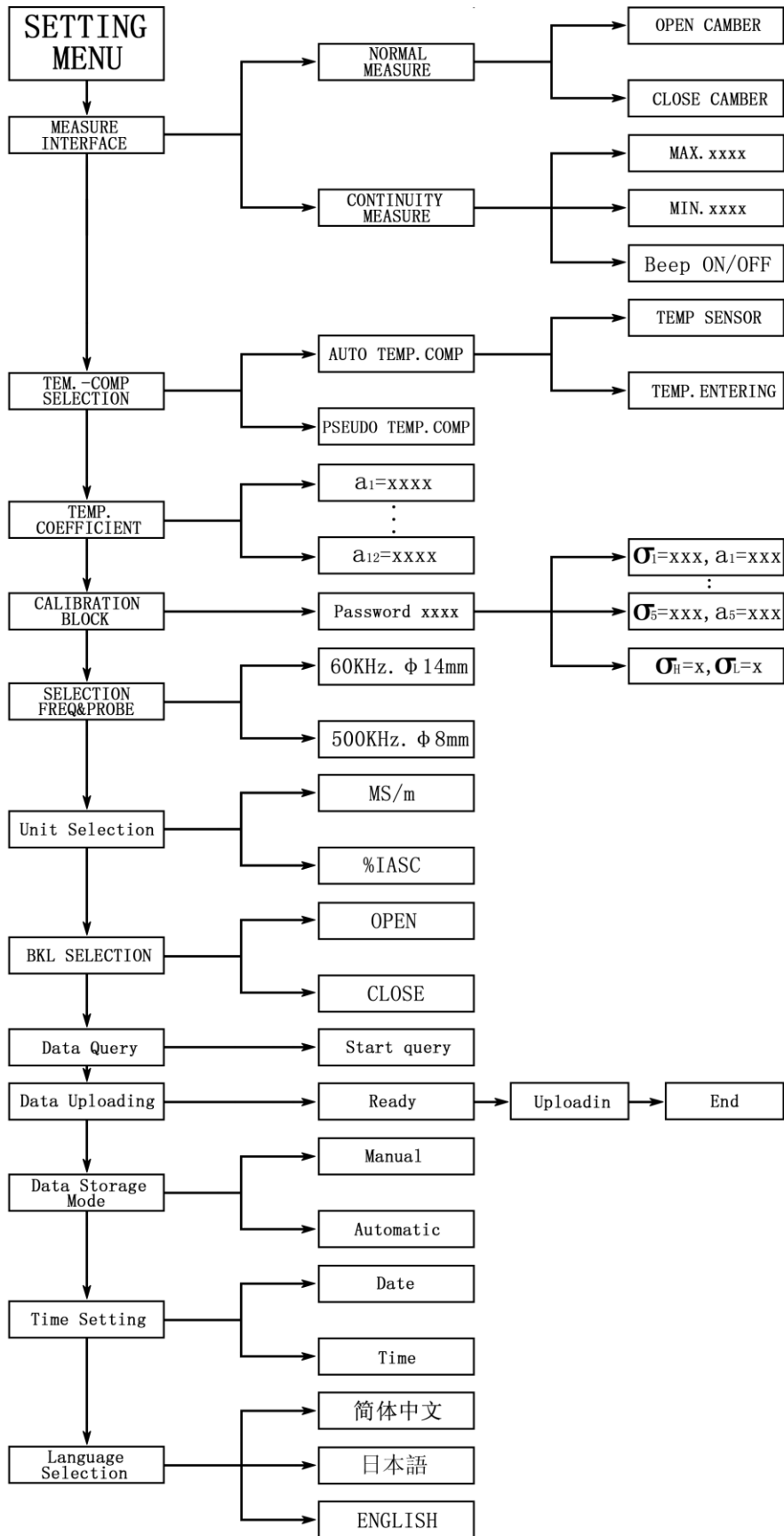

5.3.4 Setting

The following is of a set menu function table.



5.3.4.1 Setting menu

a. Press the key "SET" directly in any interface, the screen appears as below,

 (MENU) 1. MEASURE INTERFACE 2. TEMP-COMP SELECTION 3. TEMP. COEFFICIENT	 (MENU) 4. CALIBRATION BLOCK 5. FREQ. SELECTION 6. UNIT SELECTION
 (MENU) 7. BKL CHOOSE 8. DATA QUERY 9. DATA UPLOADING	 (MENU) 10. DATA STORAGE MODE 11. TIME SETTING 12. LANGUAGE SELECTION

b. Press the up “↑” or down “↓” key move the cursor to select the item, then press confirmation key "OK" to enter the settings.

c. In the settings, if press the setting key "SET" or measuring key "MEAS" will return to their respective main interface

5.3.4.2 Measurement Interface

 (MEASURE INTERFACE)
NORMAL <input checked="" type="checkbox"/>
COTINUITY <input type="checkbox"/>

a. Press upward key “↑” or downward key “↓” to select the project, when choose normal measurement, press "OK" button to confirm (tick inside the box), enter into the

following interface, press "↑" or "↓" button to select the curvature compensation opened or closed ,then press "OK" button to confirm (tick inside the box), exit and return to main interface.

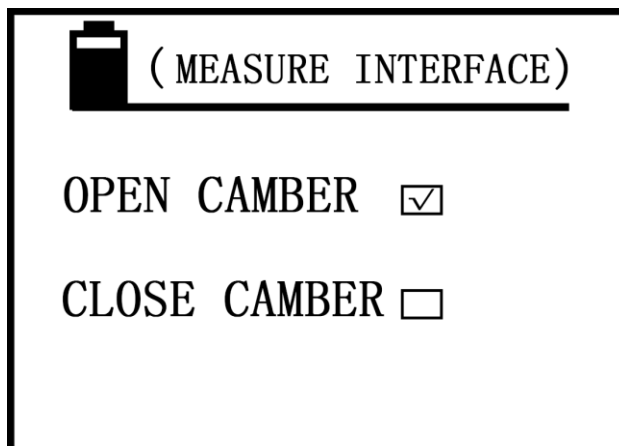

b. When choose continuity measurement, press "OK" button to confirm (tick inside box), enter into the following interface.

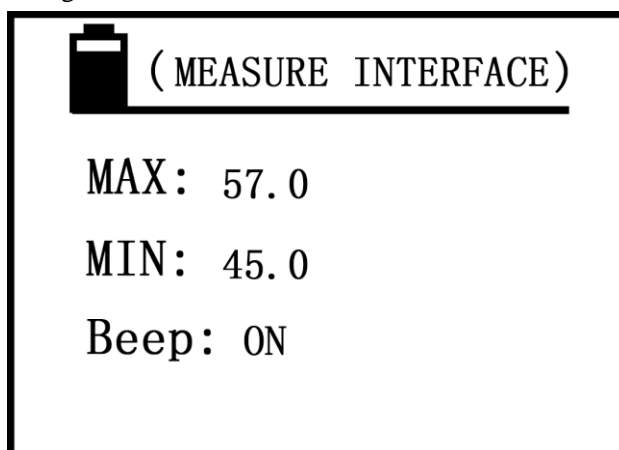

c. Press the upward key "↑" or downward movement key "↓" to select, such as choose the upper limit value, press the confirm button "OK" into the digital part, and using increasing bond "↑" or descending key "↓" finish the numerical modification, press "OK" button to save and enters to change the lower limited value, the way is the same as upper limit value, after the completion press the "OK" button to save the data and enter the alarm buzzer sound" Beep "to open or close, press "↑" or "↓" to select, press the "OK" button to confirm and exit return to main setting interface.

d. When the buzzer alarm sound "Beep" is selected ON, the conductivity value of specimen exceeds the preset limit value or below the lower limit value in continuity measurement interface, the instrument will sound "beep. Beep. Beep" until the end of the measurement. If choose off "Beep" will be silent.

5.3.4.3 Temperature compensation mode

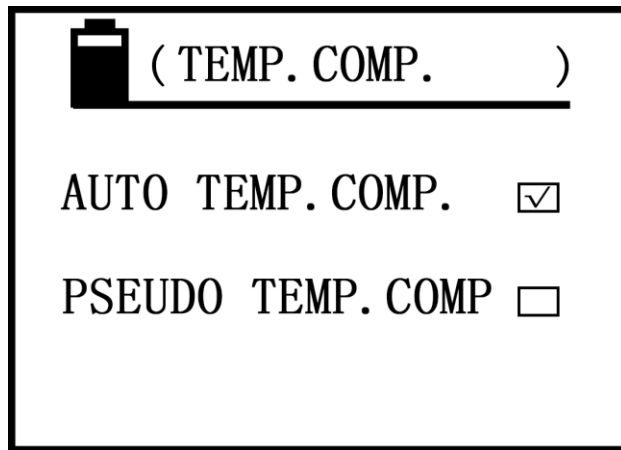

a. Press upward key "↑" or downward key "↓" to select the project, When choice is "pseudo temp.comp.", press "OK" button to confirm (tick inside box) then return to main interface. When the choice is "automatic temperature compensation," press "OK" button to confirm (tick inside box) and enter into the following interface.

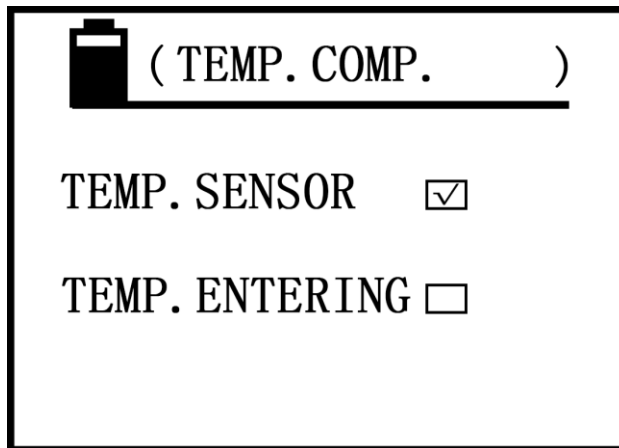

b. Use key "↑" and "↓" to select the temperature sensor or manual input temperature, and then press "OK" key to confirm and exit to return settings interface

5.3.4.4 Temperature coefficient setting

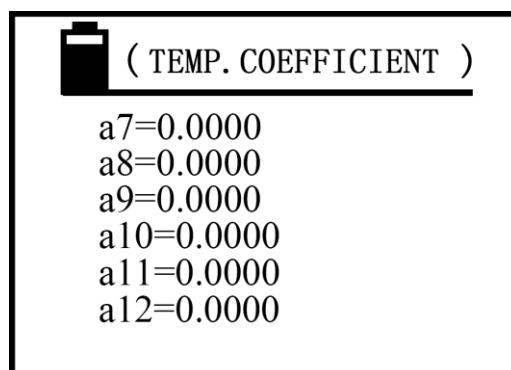
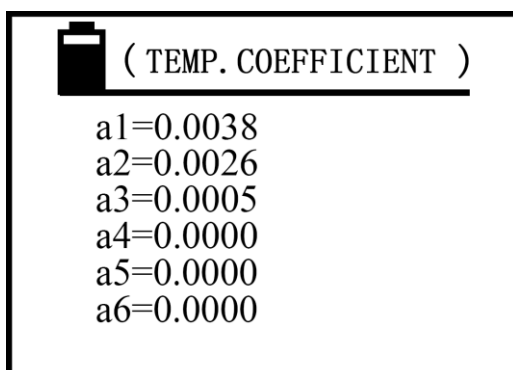



a. Press upward key "↑" or downward key "↓" to select an a_n to modify or to add , then click "OK" button to confirm the cursor moves into the digital part, then press the ascending key "↑" or decreasing key "↓" to modify values (if holding down the "↑" key or "↓" key can change numerical quickly), after the completion press the "OK" button,

save a_n numerical and the cursor automatically moves to the a_{n+1} item. Press "SET"(or" MEAS "key) key to exist and then return to main interface or the main measurement interface.

- b. a_n temperature coefficient value must be set from a_1 to a_{12} one by one, a_n must be placed in the end when it is equal to zero value , otherwise when the value of a_n set zero, numerical value a_{n+1} can not be called by measurement interface.
- c. A total of 12 values of the temperature coefficient a_n preset by users own, they are called for measurement.
- d. The valid setting range of a_n is“0.0000~0.0300”

5.3.4.5 Calibration block

 (CALIBRATION BLOCK) $\sigma_1=58.5\text{MS/m}$ $a_1=0.0038$ $\sigma_2=38.1\text{MS/m}$ $a_2=0.0038$ $\sigma_3=16.8\text{MS/m}$ $a_3=0.0040$	 (CALIBRATION BLOCK) $\sigma_4=5.80\text{MS/m}$ $a_4=0.0008$ $\sigma_5=0.59\text{MS/m}$ $a_5=0.0002$ $\sigma_H: 1$ $\sigma_L: 4$
---	---

- a. σ_1 to σ_5 are conductivity value preset calibration block at 20°C , a_1 to a_5 are the temperature coefficient corresponding to the σ_1 to σ_5 of calibration standard block . Units of measurement of the default instrument unit, determine by the item 5.3.4.7 unit selection.
- b. Press the upward key “ \uparrow ”or downward movement key” \downarrow ” to select the project to change, press the "OK" key to move to the numerical part, use " \uparrow " and " \downarrow " key to modify the value (if press and hold " \uparrow " " \downarrow " button can modify value quickly), press "OK" button to save values, and the cursor automatically move to the next project. When the cursor is moved to σ_H , press "OK" button to confirm, use " \uparrow " and " \downarrow " key to choose the number of 1 to 5(one of σ_1 to σ_5 blocks set as the instrument high value calibration block), press the "OK" button to save the value and move the cursor to σ_L , press "OK" button to confirm, use " \uparrow " and " \downarrow " key to choose the number from 1 to 5 (select one of σ_1 to σ_5 blocks as the instrument low value calibration block). Press the "OK" button to save and return to the main setting interface.
- c. The choice of σ_H and σ_L and the corresponding temperature coefficient, is provided to the high and low conductivity block called for instrument standard ,must note that σ_H should be greater than σ_L value, otherwise the selection is invalid.
- d. Setting range of conductivity σ is "0.300 ~ 65.0MS/m or 0.517 ~ 112.0%IACS" (when the standard block conductivity value < 3MS/m or 5.170%IACS and the numerical should exact to three digits and must be set in σ_4 or σ_5). Setting range of temperature coefficient value is"0.0000 ~ 0.0300"

e. To prevent mistaking into the calibration setting interface block, before entering the interface, should enter the password authentication interface, continuous inputting "STORE" button four times (password "□" box fill four small black spots, more or less filling are invalid), and press the confirm button "OK" to enter the settings screen, press the other keys are invalid during this process.

5.3.4.6 Selection frequency and probe

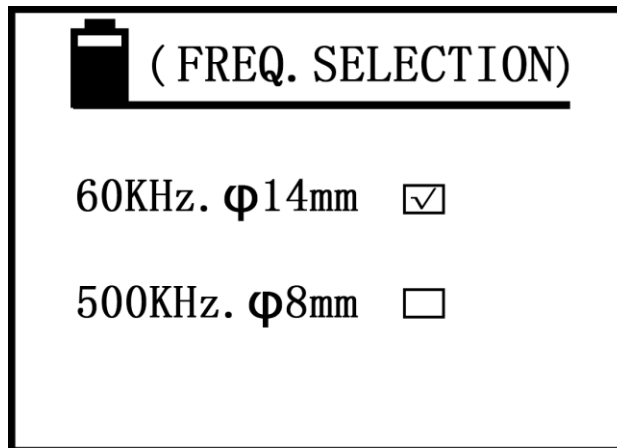

a. Press upward keys" ↑ " or downward key "↓" to select the project (tick inside the block), press "OK" key to save and return to "remind changing probe, re-calibration" interface, seeing the picture below. Then press measurement key "MEAS" or wait the interface timing finished automatically to go into the measurement interface.

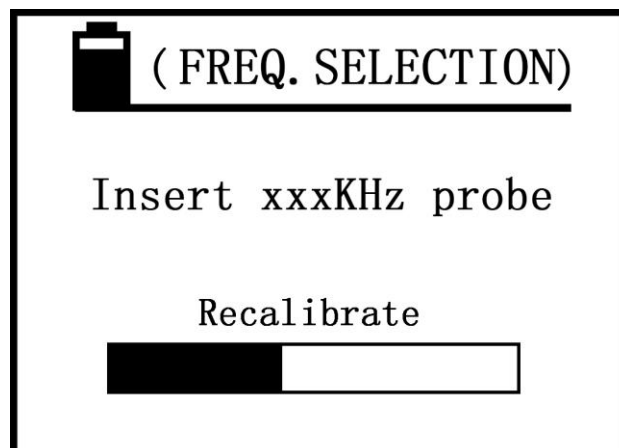

b. 60 kHz and 500 kHz is the working frequency of the instrument probe, 60 kHz φ14mm is for aviation industry standard, and 500 kHz φ 8mm is for detection of sheet material or small area of the work pieces material.

c. 2008B1 Sigma type conductivity meter can not enter the interface. Sigma 2008B type machine can be selected according to the working frequency of the probe.

5.3.4.7 Unit selection

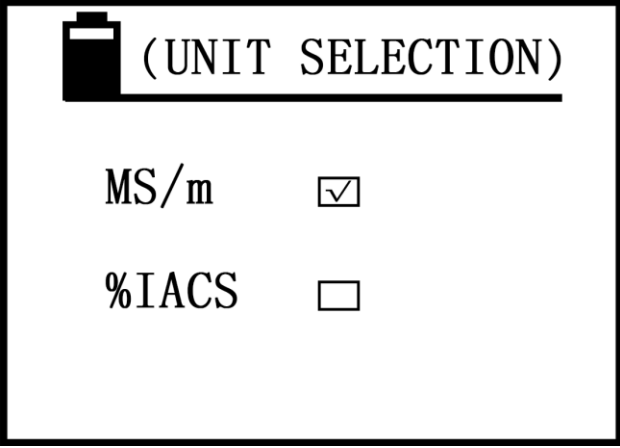

(UNIT SELECTION)	
MS/m	<input checked="" type="checkbox"/>
%IACS	<input type="checkbox"/>

- Selection method is the same as “frequency and probe selection” a.
- When choose the measurement unit, the instrument default the unit automatically , conductivity value unit will change to the default units automatically on any surface , the value is updated based on the conversion between the two units, and storage of conductivity values is the same as the default unit until the next change.

5.3.4.8 Back-light selection

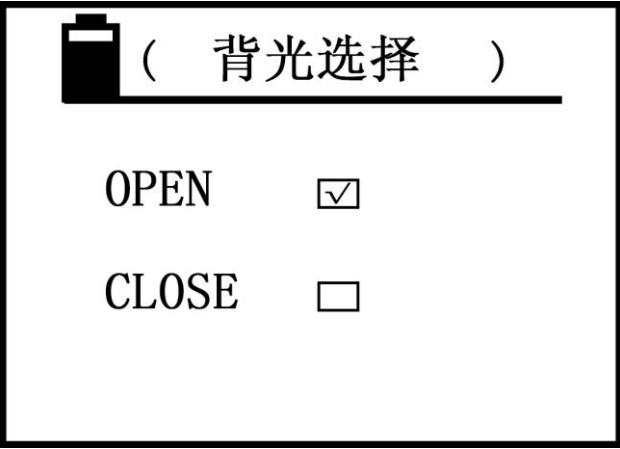

(背光选择)	
OPEN	<input checked="" type="checkbox"/>
CLOSE	<input type="checkbox"/>

- press upward keys” \uparrow ” or downward key ” \downarrow ” to select (tick inside the block), press the "OK" button to confirm “open” or “close”, and then exist and return into the main setting interface.

5.3.4.9 Data query

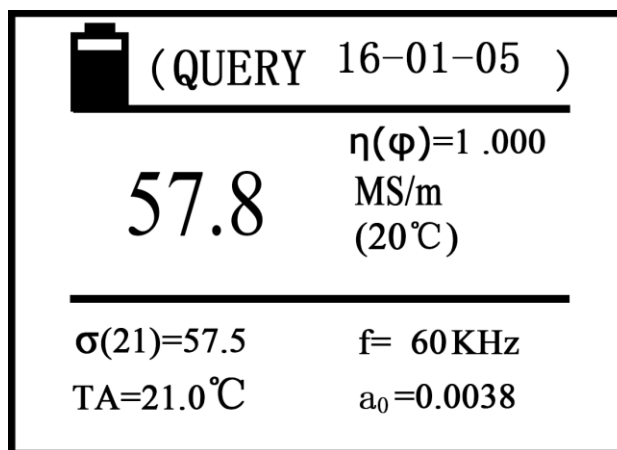

Description:

- The function is to query the measured data which saved in the past (a total of 16000 groups).
- Digital on the right of Chinese word “query” of the screen above represent of measurement date of the page data.
- In the middle of the screen, the letter N said the save number of measuring data of the page. Numbering order is from small to large, namely the current measurement data is updated to the first group automatically and the last measurement data updates for the second group, and so son total can save 16000 groups.
- Enter the query interface, the screen saves number one page first, press shift key” \uparrow ” or downward key “ \downarrow ” can query last group or following group preserved of measurement data, in the end can press the confirm button "OK" exit and return to the main setting interface.
- How to delete the saved data: in any of the query page of measured data, click the delete button to delete the saved data of the page, if press the delete key "DEL" for about 3 seconds, you can delete all saved data. When all saved data delete, screen display "empty" language tips, press "OK" key to exit and return to the main setting interface.

5.3.4.10 Data uploading

- The function is to upload measurement data to the host PC which saved in the past. Upload data from the number of 1 to the last page.
- The communication parameters of the instrument and the host computer PC are as follows
 - Potter rate: 2400bps
 - Data bits : 8
 - Parity: 无 None
 - Stop bit: 1

The driver of the upper PC machine is illustrated with a U-disk (or optical disk).

- Into uploading, the screen display "ready" tips firstly, check the below, now the user prepare for the uploading, for example if connect with the upper PC, the upper PC

machine has been installed the driver and in a state of receiving the data.

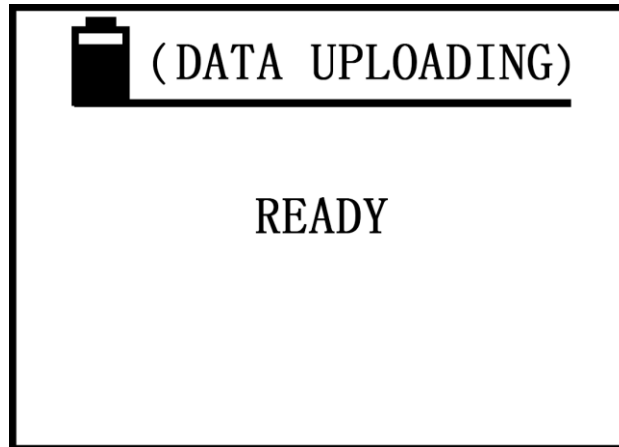

- d. Press the "OK" key, the instrument start to upload the data, the screen display "Uploading" prompt, check the figure below.

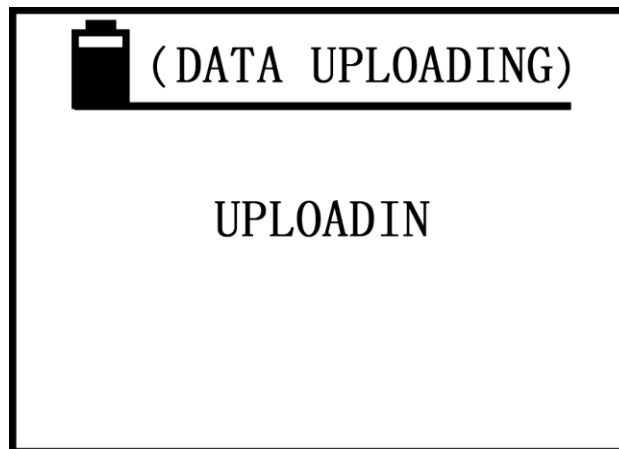

- e. Uploading finished, the screen display "END" prompt, check the figure as below, then press "OK" key exist and return to the main setting interface.

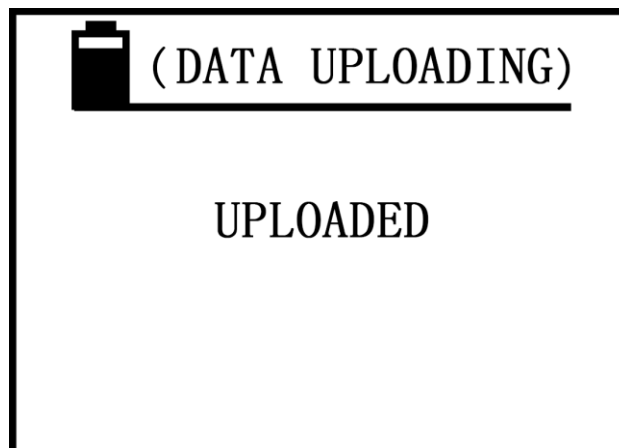

5.3.4.11 Data storage mode

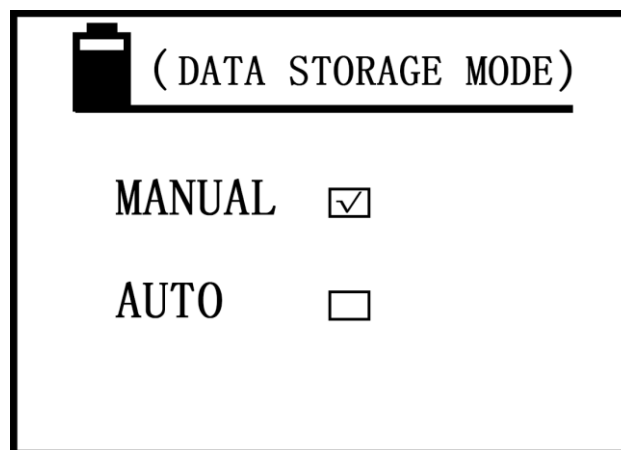

- a. Selecting method is the same as “selection freq.&probe” .
- b. Instrument storage method has” manual "and" automatic ",both are effective in the main measurement interface .Saved information is the current measurement data include" σ (20), σ (TC), units of measurement, temperature TA and measure frequency f , A_0 value, date” and so on. Save total 16000 sets of measurements data.
- c. Manual save: in the main measurement interface, keep the probe contacting with the sample after measured test conductivity values, press the storage data key "STORE", at this time, N=XXX character in the middle of the screen will flash said measurement data of the page has been saved.
- d. Automatic save: the instrument measure a valid data every time, N=XXX character in the middle of the screen will flash and save the page of the measurement data automatically.
- e. Every time shut off and power on again, the instrument will default manual save mode automatically.
- f. N=XXX numerical is the stored set of memory in the saving process, when full of 16000 sets , the screen shows "FULL" prompt, the user must empty memory then can continue to implement storage function.(Delete memory method see 5.3.4.9 data query e).
- g. The measurement unit for conductivity value of the saved data is the default unit of the instrument (see 5.3.4.7), which has nothing to do with the unit “ $\frac{DEL}{UNIT}$ ”selected for the measurement interface.

5.3.4.12 Time setting

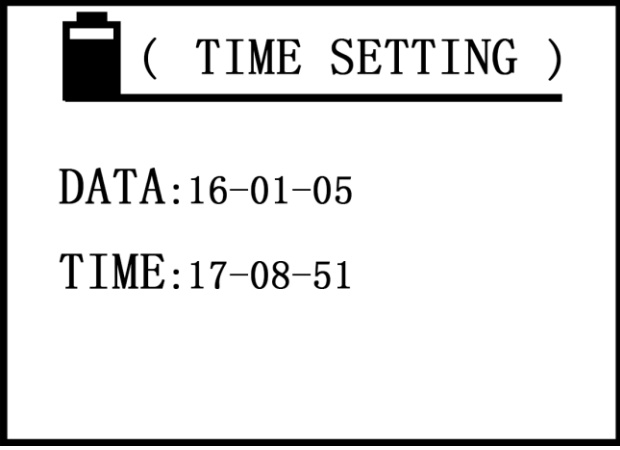

(TIME SETTING)

DATA: 16-01-05

TIME: 17-08-51

- Press the upward key "↑" or downward key "↓" move the cursor to select date or time project, press the confirm button "OK" moves in selected items of the unit 1 figures, and then use increasing key "↑" or descending key "↓" modify values (if keep holding down the "↑" "↓" button can modify numerical quickly), press the "OK" button to save unit one, the cursor moves into the unit two digital, and analogy as that until modify the unit three, and then press the "OK" button to save unit 3 and quit the project, the cursor moves to the time project, setting method is the same as date. If time project exit, return the main setting interface.
- The first unit of date items can be set within "00 ~ 99" years, the second unit can be "00 ~ 12" months, and the third unit can be "00 ~ 31" days.
- The first unit of time items can be set within "00 ~ 24" hours, the second and the third unit can be set within "00 ~ 60" points and seconds.

5.3.4.13 Language selection



(LANGUAGE SELECT)

简体中文

日本語

ENGLISH

Press upward keys "↑" or downward key "↓" to select the project (tick inside the block), press the "OK" button to confirm (The instrument keep this item until next selection), and then exist and return to the main setting interface.

六、 Influencing factors of measurement

6.1 Temperature influence

6.1.1 Material conductivity value dependent on its temperature very well, conductivity values decrease with the increase of temperature usually. Such as copper conductivity values is 58.0MS/m at 20°C, when the temperature rises to 25°C, conductivity values is 56.9MS/m. Below is relationship for conductivity, temperature and temperature coefficient.

$$\sigma(T) = \frac{\sigma(20)}{1 + a(T - 20)}$$

$\sigma(T)$: Conductivity under the temperature T

$\sigma(20)$:conductivity under the temperature of 20°C

a :Temperature coefficient of material

T : Temperature of material

6.1.1.1 Temperature coefficient a may refer to Appendix 1.

6.1.1.2 A variety of temperature compensation methods are established to meet the user's choice of different occasions based on the relationship between the conductivity value , the temperature and the temperature coefficient of the instrument,

6.1.1.3 The conductivity can be measured accurately when select correct temperature compensation mode and temperature coefficient.

6.1.2 Summery of the interaction between temperature compensation method, various of methods and the material temperature coefficient, and how to measure the temperature coefficient of unknown material.

6.1.2.1 "pseudo temperature compensation"

This is one of the most simple and efficient common modes, measurement or calibration without taking into account the temperature value and input temperature coefficient values, as long as meeting the following two conditions.

① The temperature of the material to be tested shall be the same as the temperature of the calibration test block. The instrument is calibrated with the value of standard test block at 20°C, and the conductivity value of the unknown material is equal to the compensation value at 20°C.

② The material to be tested has the same temperature coefficient as the standard block used for calibration.

Example1: If the users want to measure the unknown copper or aluminum material, the calibration uses the copper and aluminum standard test block, as long as the test of copper and aluminum material has the similar temperature coefficient with the standard test block(that is -0.004), the measured value is correct.

Example2: If the user uses a standard test block replaced the standard test block provided by the manufacturer but is similar to the material to be tested, , if the temperature coefficient is the same as that of the material to be tested, the measured value is correct.

6.1.2.2 “Automatic temperature compensation ---temperature sensor” mode

This model must be inserted into the external temperature sensor, and measure and read the stable temperature value of standard testing block or the measured material before calibration and measurement. Also should choose to measure the temperature coefficient of the material at the time of measurement, and then measure the conductivity. The operation is relatively cumbersome, but applies to any occasions, has higher accuracy, such as:

① Can be used on the occasion when temperature of the calibrated test block is different from that of the material to be tested.

Example 1: Users use two calibration blocks (both are assigned the temperature coefficient) to calibrate instrument under a temperature, measuring one of calibration blocks with external temperature sensor (both testing blocks have the same temperature), select the value until temperature stable (see 5.3.2.6). Then put the eddy current probe in the high and low values of calibration block to calibrate instrument. After calibration, begin to measure the temperature conductivity value of different materials. Same with the calibration, use temperature sensor to measured temperature value first(see 5.3.2.5), then select the temperature coefficient value a_0 (see 5.3.2.6), finally flat the eddy current probe on the material to measure the conductivity value, instrument display two conductivity readings, both of them are the conductivity values under the current temperature and under 20°C.

Example2: if users are using their own standard test blocks for calibration, first of all, place the standard test block conductivity value and temperature coefficient numerical into the instrument internal (see 5.3.4.5) and selected as high value or low value calibration block, calibration and measurement method is the same as example1.

② The temperature coefficient value of the material can be obtained by the conductivity value measured of the mode.

Example: measure the temperature coefficient of material. Firstly measure and record the conductivity value tested by the calibration instrument at 20°C stable conditions, then heating constant the material in a certain temperature (not more than +40°C), measure the temperature value and the conductivity value $\sigma(TA)$ under the current temperature, according

to formula $\sigma(T) = \frac{\sigma(20)}{1 + a(T - 20)}$ can tested the temperature coefficient a of the material.

6.1.2.3 “Automatic temperature compensation-manual entering temperature ” mode

This model without inserting an external temperature sensor to calibrate temperature of testing block and the testing material , only need to input temperature T_A manual when calibrate (see 5.3.2.5), the other operation methods are the same as and mode 6.1.2.2. The model applied to have known temperature of calibration testing block and the testing material already.

6.2 Lift-off influence

The error influence of the conductivity measurement by distance between the testing material and the probe. The lift-off compensation with a diameter of 14mm probe can be about 500 μm and diameter of 8mm probe can be about 200 μm of this serial product. The practical application effect is when the non conducting layer (such as paint, plastic thin film, dust, etc.) between the probe and the measured material is less than distance from the lift-off compensation, the measuring conductivity value is correct. Beyond the distance from the lift-off compensation, the measuring conductivity value will have a greater error.

6.3 Material thickness influence

If the actual material thickness is less than 3 times of the standard penetration depth of the eddy current standard, the measurement accuracy can not be guaranteed. The standard penetration depth is determined by the frequency and the conductivity. The following relationship applies,

$$\delta = \frac{503}{\sqrt{f \sigma}}$$

σ =conductivity in MS/m

f =testing frequency in Hz

δ =standard penetration depth in mm

6.3.1 Figure 6.1 shows the dependence between the thickness of the material and the conductivity and the test frequency, the minimum material thickness required by 3 times the standard penetration depth ($3 \times \delta$).

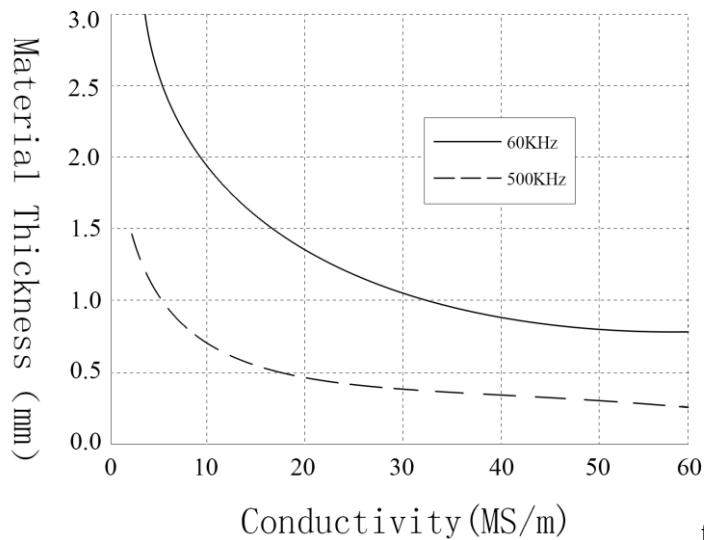

figure 6.1

6.3.2 If the thickness of the material is less than required thickness of $3 \times \delta$, the thickness of the same material can be superposed to achieve the minimum thickness. In order to achieve the true credibility of the measurement results, we should pay attention to the following aspects:

- ① In the premise of meeting the minimum thickness, the less the number of layers is more reliable.
- ② Between layer and layer should be treated clean, to reduce the error can not have dust isolation,
- ③ The layer and layer should be compacted to reduce air gap, generally not more than three layers.

6.4 Camber influence

Camber has a direct influence on measurement value. Conductivity calibration use planar calibration testing block, the probe impedance changes only with material conductivity. When the probe measures on the camber, the probe impedance changes not only with the conductivity but also with the diameter of the material surface. According to the following relationship established formula of curvature compensation.

$$\sigma = \frac{\sigma(\varphi)}{\eta(\varphi)}$$

σ : the real conductivity value of material

$\sigma(\varphi)$: conductivity value of material with the curvature diameter φ

$\eta(\varphi)$ is correction factor for curvature diameter , the user get the relation curve for correction coefficient $\eta(\varphi)$ and diameter according to the the same material with different curvature diameter(with same conductivity).

Example 1: using diameter 14mm, conductivity values 60KHZ probe to measure the conductivity of convex surface, the curvature diameter of work piece is 50mm, measuring

convex surface conductivity value $\sigma(\varphi)=56\text{MS/m}$.

Hypothesis: curvature coefficient $\eta(\varphi) = 0.975$ of convex pieces with curvature diameter of $\varphi=50\text{mm}$ ($\eta(\varphi)$ input see 5.3.2.7)

The actual conductivity $\sigma_{\text{act.}} = \sigma(\varphi) / \eta(\varphi) = 56 / 0.975 = 57.4\text{MS/m}$

Example 2: using diameter 14mm, conductivity values 60KHZ probe to measure the concave surface of the work piece, the curvature diameter of work piece is 60mm, measuring concave surface conductivity value $\sigma(\varphi)=58\text{MS/m}$

Hypothesis: curvature correction coefficient $\eta(\varphi) = 1.032$ of work piece of curvature diameter $\varphi= 60\text{mm}$ ($\eta(\varphi)$ input see 5.3.2.7)

The actual conductivity $\sigma_{\text{act.}} = \sigma(\varphi) / \eta(\varphi) = 58 / 1.032 = 56.2\text{MS/m}$

6.5 Edge Effect

The eddy current probes of the instrument are all used of electromagnetic shielding technology, it has a significant difference from other not shielded probes(see Figure 6.2), diameter of 14mm probe can measure the minimum area which has the diameter larger than or equal to that of the probe, the diameter of 8mm probe can measure the minimum area which has the diameter larger than or equal to that of the probe.

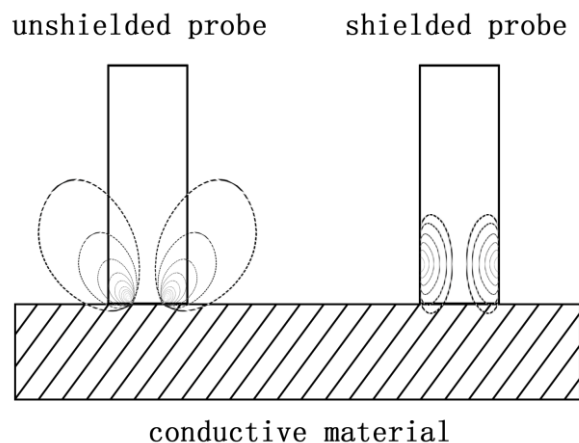

figure 6.2

And the measurement of the diameter of the non-shield probe is far greater than the diameter of the probe, otherwise it will produce errors.

七、 POINTS FOR ATTENTION AND MAINTENANCE

7.1 During calibration or measurement, need to keep the probe touching the sample

- surface vertically and smoothly, putting down or picking up gently, handling evenly.
- 7.2 It's not suitable to hold the probe for a long time. which will cause the temperature rise of the probe to affect the measurement accuracy.
- 7.3 Should try to keep the standard block, the test piece, the instrument, and the probe working under the conditions that the temperature fluctuations not big.
- 7.4 Instrument and standard test block shall be used and preserved in the environment of .non-corrosion, non- vibration and non-electromagnetic interference.
- 7.5 The testing work shall be carried out at a temperature of 0 ~ 50°C.
- 7.6 The test should be kept away from the radiator, fan, fire, and avoid direct sunlight.
- 7.7 Do not touch the end of the probe, standard block and the testing parts of the testing piece with a finger.
- 7.8 Standard block, test piece, and the probe end should be promptly cleared if there is grease, dust and other dirt,
- 7.9 Instrument and the probe should be prevented vibration, collision, and the standard block surface should not be severely scratched.
- 7.10 End of the probe if serious abrasion should be replaced with a new probe, in case not affect the accuracy of measurement.

八、 **USERS NOTES**

- 8.1 This instrument is guaranteed for 1 year.
- 8.2 In the following circumstances, the company or the agency authorized by company is not responsible for the product free warranty, but still provide maintenance services by paid.
- 8.2.1 Don't connection, maintenance and safekeeping according to instructions manual that resulting in product failure or damage.
- 8.2.2 Beyond the warranty period
- 8.2.3 Product warranty card number doesn't match with the product itself.
- 8.2.4 Disassembled or repaired the host or parts by personnel of non-company or the company non-authorized.
- 8.2.5 Components that do not belong to the warranty (testing probe, rechargeable batteries, shell, keyboard, connecting wire)
- 8.2.6 Accident or man-made action causes damage to the product.
- 8.2.7 Product failure or damage caused by irresistible factors such as earthquake, fire, etc

**APPEDIX1: TABLE OF CONDUCTIVITY VALUE FOR
COMMON MATERIAL AND TEMPERATURE COEFFICIENT**

METAL	CONDUCTIVITY (20°C)		TEMP. COEFFICIENT (20°C)
	%IACS	MS/m	
Copper	100	58	0.0038
Aluminum	29~61	17~35.4	0.0040
Gold	70.7	41	0.0034
Silver	108	62.5	0.0038
Brass (H90)	43.10	25	0.0018
Aluminum bronze	9	5.2	~0.0008
Titanium	3.6	2.08	0.0040
Lead	7.8	4.5	0.0039
Zinc	30	17.4	0.0037
Nickel	22	12.8	0.0060
Magnesium	38	22	0.0040
Nickel silver	8.6	5	0.00068
Titanium alloy	1.02	0.59	0.0002
Tungsten	31.46	18.25	0.0052
Platinum	17.24	10	0.000374
Constantan	3.92	2.27	0.000005
Manganin copper	4.1	2.38	0.000005

APPEDIX2: CONTACTS

Name: Xiamen Tianyan instrument co.,Ltd.

Address: Room 614 chuangye building pioneering part,hi-tech zone, huli block,
Xiamen,China.

Post code: 361009 | Wedsite: www.xmty1.com | Mail: ty@xmty1.com

Fax: 0592-3195307

Sales telephone: 0592-3195306/ 18060926989

0592-3195308/ 18050108768

Technical telephone: 0592-3195309